

**PRODUCT SPECIFICATIONS**

**Cutoff** 45° visual cutoff to lamp and lamp image

**Trims Style** Trim Ring, Self Flanged and Flangeless Trims utilize torsion spring retention for tight, secure fit to ceiling • Trim ring features beveled knife edge for clean ceiling interface • Self Flanged reflectors with polished or optional white painted flange

**Lens** Lampholder accommodates up to three (3) 2" captive accessory lenses • Supplied with stippled clear uniformity lens.

**Socket** Ceramic bi-pin socket with double blade nickel alloy contacts • Quick disconnect for simplified maintenance.

**Lamp** One 50W MR16 lamp max for IC43N. One 75W MR16 lamp max for TC43N (TC943N).

**Adjustability** Acu-Aim™ precision geared hot-aiming achieves 370° rotation, 45° tilt • Optimized center lamp beam optics translates lamp forward as it is aimed off nadir, ensuring maximum light and low brightness • Black aiming mechanism with shield prevents visibility into fixture and preserves dark aperture • Shield hinges out of way to facilitate maintenance.

**Transformer** Available with either magnetic or electronic transformers, capable of 120V or 277V input.

**Magnetic Transformer** Hatch LT12-75-JLG-1 (120V) or Hatch LT12-75-JLG-1 (277V), high efficiency (>90%) dual tap magnetic, toroidal transformer (has boost tap to compensate for dimmer losses, improving color temperature and lumen output).

**Electronic Transformer** IC43N available with Hatch RS12-60M, 120V high efficiency, high power factor electronic transformer. TC43N and TC943N available with GE LET 75 (120V) or Hatch RS12-80 (277V) electronic transformers.

**Dimming** May be dimmed using dimmers specifically designed for low voltage magnetic or electronic transformers; consult factory or dimmer manufacturer for additional information.

**Codes/Labels** UL and cUL listed for direct contact with insulation, through-branch wiring, damp locations (wet location with approved trims) • Meets energy code Air Leakage requirements per ASTM E283 • Product thermally protected • Union made.

**Bar Hangers / Mounting Brackets** IC43N and TC43N features patented (US Patent 8,038,113) Pro-V™ bar hanger system, permitting quick placement of housing with 24" on-center joists or suspended ceilings. TC943N features vertically adjustable mounting brackets (butterfly brackets).

**Junction Box** IC43N rated for 4 No. 12 AWG 90° through branch conductors • TC43N and TC943N rated for 8 No. 12 AWG 90° C through branch circuit conductors • Includes (5) 1/2", (1) 3/4", and (4) Non-metallic sheathed cable knock-outs • Push-in electrical connectors for field connections.

**Housing/Mounting Frame** Black steel plaster frame and housing painted for visually dark interior • V-Notch in plaster frame aids fixture alignment during installation • Patent pending Tru-Line™ Adjustment Mechanism featuring +/- 1/2" translation aids fixture alignment after installation, prior to drywall.

**Ceiling Thickness** 1/2" – 2" ceiling  
 Specifications subject to change without notice.

**3" MR16 UNIVERSAL RECESSED ADJUSTABLE/DOWNLIGHT/WALL WASH**

MR16 Halogen

**IC43N / TC43N / TC943N**



**DIMENSIONS**

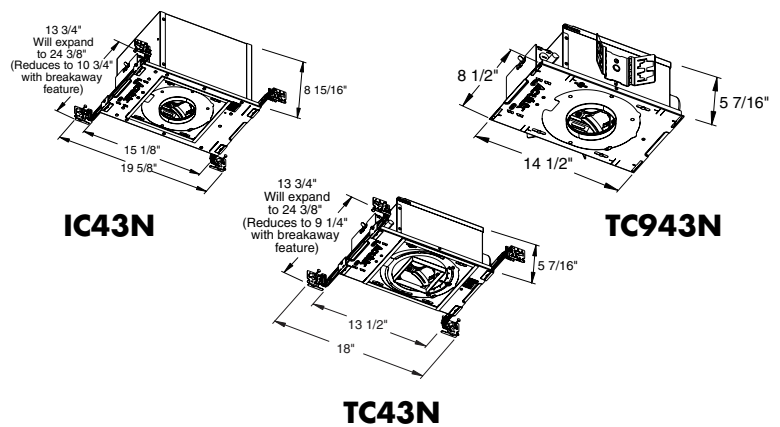

4 1/4" SQUARE CEILING CUTOUT  
 (REFER TO INSTRUCTION SHEET FOR FLANGELESS CEILING CUTOUT)

**ORDERING INFORMATION**

Example: IC43N ELV 120 3ABV BS WHFM FMA3/087

Series / Housing Style	Transformer	Voltage	Option
IC43N 3" Aculux Round MR16 IC Rated, Air tight	ELV Electronic Low Voltage	120	CP Chicago Plenum
TC43N 3" Aculux Round MR16 Non-IC	MLV Magnetic Low Voltage	277	
TC943N 3" Aculux Round MR16 Non-IC Butterfly Brackets			

HOUSING INFO

TRIM OPTIONS

Trim Style	Reflector Finish	Flange Style / Finish	Environment	Ceiling Installation
<b>ADJUSTABLE ACCENT</b>		<b>FLANGED</b>	<b>WET</b> Wet location	<b>SELF-FLANGED</b>
<b>3AC</b> <sup>4</sup> Angle-Cut Reflector 45°	<b>BS</b> Black Specular	<b>SF</b> Self Flanged (same finish as reflector)		Ceiling ≤ .875"
<b>3ASLOT</b> <sup>4</sup> Slot Cut Reflector 45°	<b>CD</b> Clear Diffuse	<b>WHSF</b> Self Flanged, White painted flange		CTA3/125 Ceiling 0.875" - 1.25"
<b>3AC20</b> <sup>4</sup> Shallow Angle-Cut Reflector 20°	<b>CS</b> Clear Specular	<b>BLSF</b> Self Flanged, Black painted flange		CTA3/163 Ceiling 1.25" - 1.625"
<b>3ABAF</b> <sup>2</sup> Angle-Cut Baffle	<b>WTD</b> Wheat Diffuse	<b>WHR</b> White Trim Ring		CTA3/200 Ceiling 1.625" - 2.00"
<b>3ABV</b> <sup>3</sup> Adjustable Bevel	<b>B</b> Black Paint	<b>SCR</b> Satin Chrome Trim Ring		<b>FLANGELESS, GYPSUM</b>
<b>3APIN</b> <sup>5</sup> Adjustable Pinhole, 1 1/4"	<b>W</b> White Paint	<b>ABZR</b> Aged Bronze Trim Ring		<b>FMA3/087</b> Ceiling ≤ .875"
<b>3APINLG</b> <sup>5</sup> Adjustable Pinhole, 1 3/4"		<b>FM</b> Flangeless		<b>FMA3/125</b> Ceiling 0.875" - 1.25"
<b>3AOVAL</b> <sup>3</sup> Adjustable Slot Pinhole		<b>WHFM</b> Flangeless, White trim		<b>FMA3/163</b> Ceiling 1.25" - 1.625"
<b>DOWNLIGHT</b>		<b>FLANGELESS</b> <sup>6</sup>		<b>FLANGELESS, WOOD/STONE/TILE</b> <sup>7</sup>
<b>3DP</b> <sup>4</sup> Parabolic Downlight Trim		<b>BLFM</b> Flangeless, Black trim		<b>SFM3/087 (B,W)</b> Ceiling ≤ 0.875"
<b>3DH</b> <sup>4</sup> Hyperbolic Downlight Trim				<b>SFM3/125 (B,W)</b> Ceiling 0.875" - 1.25"
<b>3DBAF</b> <sup>2</sup> Baffle Downlight Trim				<b>SFM3/163 (B,W)</b> Ceiling 1.25" - 1.625"
<b>3DBV</b> <sup>3</sup> Downlight Bevel				
<b>3DPIN</b> <sup>5</sup> Downlight Pinhole, 1 1/4"				
<b>WALL WASH</b>				
<b>3WW</b> <sup>4</sup> Wall Wash				

**Ordering Notes**

<sup>1</sup> Available on TC943N and TC43N only. <sup>2</sup> Available with B, W, ABZR, WHR, SCR only. <sup>3</sup> Available with BS, BLSF, WHSF, BLFM, WHFM only. <sup>4</sup> Not available with BLSF, WHFM, BLFM. <sup>5</sup> Available with BS, ABZR, BLSF, SCR, WHSF, BLFM, WHFM only. <sup>6</sup> For Flangeless trims, specify flangeless ceiling installation (FMA3 or SFM3). <sup>7</sup> Specify finish: B = Black, W = White





















NOTES

**3" MR16 UNIVERSAL RECESSED  
ADJUSTABLE/DOWNLIGHT/WALL WASH**

MR16 Halogen

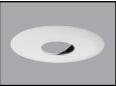
**IC43N / TC43N / TC943N**

**TRIM SELECTION**

ADJUSTABLE ACCENT				MAX. LAMP RATING		
<b>3AC</b>	Angle-Cut Reflector, 45°	Aperture : 3 1/4"				<p><b>IC-Rated (IC43N) :</b> 50W MR16</p> <hr/> <p><b>Non-IC (TC43N) :</b> 75W MR16</p> <hr/> <p><b>Non-IC (TC943N) :</b> 75W MR16</p>
						
			Trim Ring	Self-Flanged	Flangeless	
<b>3ASLOT</b>	Slot Cut Reflector, 45°	Aperture : 3 1/4"				
			Trim Ring	Self-Flanged	Flangeless	
<b>3AC20</b>	Shallow Angle-Cut Reflector, 20°	Aperture : 3 1/4"				
			Trim Ring	Self-Flanged	Flangeless	
<b>3ABAF</b>	Angle-Cut Baffle	Aperture : 3 1/4"				
			Trim Ring			
<b>3ABV</b>	Adjustable Bevel	Aperture : 1 3/4"				
			Trim Ring	Flangeless		
<b>3APIN</b>	Adjustable Pinhole	Aperture : 1 1/4"				
			Trim Ring	Flangeless		
<b>3APINLG</b>	Adjustable Pinhole, 1 3/4"	Aperture : 1 3/4"				
			Trim Ring	Flangeless		
<b>3AOVAL</b>	Adjustable Slot Pinhole	Aperture : 1 3/4" x 2 1/2"				
			Trim Ring	Flangeless		











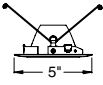













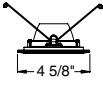

\* With WET option

**3" MR16 UNIVERSAL RECESSED  
ADJUSTABLE/DOWNLIGHT/WALL WASH**

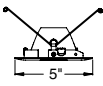
MR16 Halogen

**IC43N / TC43N / TC943N**

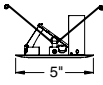
**TRIM SELECTION (continued)**

DOWNLIGHT					MAX. LAMP RATING
<p><b>3DP</b> Parabolic Downlight Trim</p>  <p>Trim Ring</p>  <p>Aperture : 3 1/4"</p> <p>Self-Flanged</p>  <p>Aperture : 3 1/4"</p> <p>Flangeless</p> 	 <p>Aperture : 3 1/4"</p> <p>Self-Flanged</p>  <p>Aperture : 3 1/4"</p> <p>Flangeless</p> 	 <p>Aperture : 3 1/4"</p> <p>Self-Flanged</p>  <p>Aperture : 3 1/4"</p> <p>Flangeless</p> 	 <p>Aperture : 3 1/4"</p> <p>Self-Flanged</p>  <p>Aperture : 3 1/4"</p> <p>Flangeless</p> 	<p><b>IC-Rated (IC43N) :</b> 50W MR16</p> <hr/> <p><b>Non-IC (TC43N) :</b> 75W MR16</p> <hr/> <p><b>Non-IC (TC943N) :</b> 75W MR16</p>	
<p><b>3DBAF</b> Baffle Downlight Trim</p>  <p>Trim Ring</p>  <p>Aperture : 3 1/4"</p> <p>Self-Flanged</p>  <p>Aperture : 3 1/4"</p> <p>Flangeless</p> 	<p><b>3DBV</b> Downlight Bevel</p>  <p>Trim Ring</p>  <p>Aperture : 1 3/4"</p> <p>Self-Flanged</p>  <p>Aperture : 1 3/4"</p> <p>Flangeless</p> 	<p><b>3DPIN</b> Downlight Pinhole</p>  <p>Trim Ring</p>  <p>Aperture : 1 1/4"</p> <p>Self-Flanged</p>  <p>Aperture : 1 1/4"</p> <p>Flangeless</p> 	<p><b>3WW</b> Lensed Wall Wash</p>  <p>Trim Ring</p>  <p>Aperture : 3 1/4"</p> <p>Self-Flanged</p>  <p>Aperture : 3 1/4"</p> <p>Flangeless</p> 	<p><b>MAX. LAMP RATING</b></p> <p><b>IC-Rated (IC43N) :</b> 50W MR16</p> <p><b>Non-IC (TC43N) :</b> 75W MR16</p> <p><b>Non-IC (TC943N) :</b> 75W MR16</p>	

**ACCESSORIES**

Cat. #	Description	Cat. #	Description
<b>CGF 200 MPINK</b>	Med. Pink Color Filter	<b>DGF 200 MAGEN</b>	Magenta Dichroic Lens
<b>CGF 200 WRED</b>	Warm Red Color Filter	<b>DGF 200 CYAN</b>	Blue Green Dichroic Lens
<b>CGF 200 DLBLUE</b>	Daylight Blue Color Filter	<b>DCCF 200 HL4250</b>	Daylight Blue Correction Lens
<b>CGF 200 MBLU</b>	Med. Blue Color Filter	<b>DIFF 200</b>	Diffuse Spread Lens
<b>CGF 200 MAMB</b>	Med. Amber Color Filter	<b>SOLITE 200</b>	Uniformity Lens
<b>CGF 200 MGRN</b>	Med. Green Color Filter	<b>UVF 200</b>	UV Filter Lens
<b>DGF 200 DRED</b>	Red Dichroic Lens	<b>PRISM 200</b>	Prismatic Lens
<b>DGF 200 MGRN</b>	Med. Green Dichroic Lens	<b>LSPREAD 200</b>	Linear Spread Lens
<b>DGF 200 MBLU</b>	Med. Blue Dichroic Lens	<b>HCLBL 200</b>	Hexcell Louver
<b>DGF 200 DYEL</b>	Yellow Dichroic Lens		

*To order, specify catalog number.*

\* With WET option

**3" MR16 UNIVERSAL RECESSED  
ADJUSTABLE TRIMS**

MR16 Halogen

**IC43N / TC43N / TC943N**

**PHOTOMETRICS**

**CBCP** · Centerbeam candlepower  
**FC** · Footcandles at beam center (aim point)

In vertical aiming applications, aim point (X) is determined by dividing distance from the wall (D) by the tangent of the desired aim angle (A) (0.5774 for 30°, 1.0 for 45°).

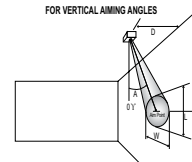
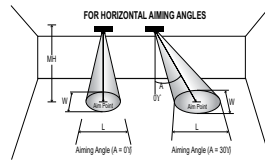

Lamp	Beam Type	Beam Spread°	Rated Life	CBCP	0°			30°			30°			45°						
					MH	FC	L	W	FC	L	W	D	FC	X	L	W	FC	X	L	W
37W MR16 Halogen IR	NSP	10°	5000	12500	6	347	1.0	1.0	226	1.4	1.2	3	174	5.2	2.1	1.0	491	3.0	1.1	0.7
					8	195	1.4	1.4	127	1.9	1.6	4	98	6.9	2.9	1.4	276	4.0	1.4	1.0
					10	125	1.7	1.7	81	2.3	2.0	5	63	8.7	3.6	1.7	177	5.0	1.8	1.2
	NFL	25°	5000	4400	4	275	1.8	1.8	179	2.4	2.0	2	138	3.5	4.2	1.8	389	2.0	1.9	1.3
					6	122	2.7	2.7	79	3.6	3.1	3	61	5.2	6.2	2.7	173	3.0	2.8	1.9
					8	69	3.5	3.5	45	4.8	4.1	4	34	6.9	8.3	3.5	97	4.0	3.7	2.5
	FL	35°	5000	2200	3	244	1.9	1.9	159	2.6	2.2	2	69	3.5	7.2	2.5	194	2.0	2.8	1.8
					4	138	2.5	2.5	89	3.5	2.9	3	31	5.2	10.8	3.8	86	3.0	4.2	2.7
					6	61	3.8	3.8	40	5.2	4.4	4	17	6.9	14.4	5.0	49	4.0	5.6	3.6
42W MR16 Halogen	VNSP	9°	3500	12300	8	192	1.3	1.3	125	1.7	1.5	4	96	6.9	2.6	1.3	272	4.0	1.3	0.9
					10	123	1.6	1.6	80	2.1	1.8	5	62	8.7	3.2	1.6	174	5.0	1.6	1.1
					12	85	1.9	1.9	55	2.5	2.2	6	43	10.4	3.8	1.9	121	6.0	1.9	1.3
					14	63	2.2	2.2	41	2.9	2.5	7	31	12.1	4.5	2.2	89	7.0	2.2	1.6
	NFL	25°	6000	3200	4	200	1.8	1.8	130	2.4	2.0	2	100	3.5	4.2	1.8	283	2.0	1.9	1.3
					6	89	2.7	2.7	58	3.6	3.1	3	44	5.2	6.2	2.7	126	3.0	2.8	1.9
					8	50	3.5	3.5	32	4.8	4.1	4	25	6.9	8.3	3.5	71	4.0	3.7	2.5
	FL	40°	6000	1700	3	189	2.2	2.2	123	3.0	2.5	2	53	3.5	9.7	2.9	150	2.0	3.4	2.1
					4	106	2.9	2.9	69	4.1	3.4	3	24	5.2	14.5	4.4	67	3.0	5.0	3.1
6					47	4.4	4.4	31	6.1	5.0	4	13	6.9	19.3	5.8	38	4.0	6.7	4.1	
50W MR16 Halogen IR Lensed	SP	10°	5000	15000	6	417	1.0	1.0	217	1.4	1.2	3	208	5.2	2.1	1.0	589	3.0	1.1	0.7
					8	234	1.4	1.4	152	1.9	1.6	4	117	6.9	2.9	1.4	331	4.0	1.4	1.0
					10	150	1.7	1.7	97	2.3	2.0	5	75	8.7	3.6	1.7	212	5.0	1.8	1.2
					12	104	2.1	2.1	68	2.8	2.4	6	52	10.4	4.3	2.1	147	6.0	2.1	1.5
	NFL	25°	5000	5700	4	356	1.8	1.8	231	2.1	2.0	2	178	3.5	4.2	1.8	504	2.0	1.9	1.3
					6	158	2.7	2.7	103	3.6	3.1	3	79	5.2	6.2	2.7	224	3.0	2.8	1.9
					8	89	3.5	3.5	58	4.8	4.1	4	45	6.9	8.3	3.5	126	4.0	3.7	2.5
	FL	35°	5000	2850	3	317	1.9	1.9	206	2.6	2.2	2	89	3.5	7.2	2.5	252	2.0	2.8	1.8
					4	178	2.5	2.5	116	3.5	2.9	3	40	5.2	10.8	3.8	112	3.0	4.2	2.7
6					79	3.8	3.8	51	5.2	4.4	4	22	6.9	14.4	5.0	63	4.0	5.6	3.6	
71W MR16 Halogen	SP	15°	4000	11500	6	319	1.6	1.6	207	2.1	1.8	3	160	5.2	3.3	1.6	452	3.0	1.6	1.1
					8	180	2.1	2.1	117	2.8	2.4	4	90	6.9	4.4	2.1	254	4.0	2.1	1.5
					10	115	2.6	2.6	75	3.5	3.0	5	58	8.7	5.6	2.6	163	5.0	2.7	1.9
					12	80	3.2	3.2	52	4.2	3.6	6	40	10.4	6.7	3.2	113	6.0	3.2	2.2
	NFL	25°	4000	5500	4	344	1.8	1.8	223	2.4	2.0	2	172	3.5	4.2	1.8	486	2.0	1.9	1.3
					6	153	2.7	2.7	99	3.6	3.1	3	76	5.2	6.2	2.7	216	3.0	2.8	1.9
					8	86	3.5	3.5	56	4.8	4.1	4	43	6.9	8.3	3.5	122	4.0	3.7	2.5
	FL	40°	4000	2200	3	244	2.2	2.2	159	3.0	2.5	2	69	3.5	9.7	2.9	194	2.0	3.4	2.1
					4	138	2.9	2.9	89	4.1	3.4	3	31	5.2	14.5	4.4	86	3.0	5.0	3.1
6					61	4.4	4.4	40	6.1	5.0	4	17	6.9	19.3	5.8	49	4.0	6.7	4.1	

The beam spread in degrees and the beam "L" and "W" in the following tables are computed at 50% of centerbeam candlepower and represent areas of "effective illumination."

3DP Parabolic Downlight Trim Aperture : 3 1/4"

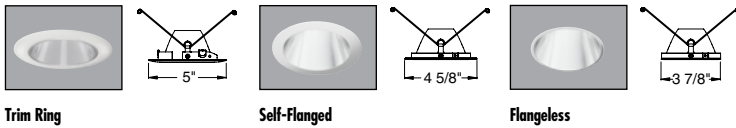

Trim Ring

Self-Flanged

Flangeless

3" MR16 UNIVERSAL RECESSED DOWNLIGHT

MR16 Halogen

IC43N / TC43N / TC943N with 3DP Trim

PHOTOMETRICS

PHOTOMETRIC REPORT

Catalog Number: IC43N 3DP CS WHR

Test Number: PT12090803

Total Luminaire Efficiency: 69.3%

Luminaire Spacing Criteria: 0.54

Luminaire: Clear specular Alzak® downlight trim. Open aperture.

Lamps: One 37MR16/1R/FL35/C, rated at 800 total lumens.

Initial Footcandles

Distance to Illuminated Plane (Feet)	Footcandles Beam Center	Footcandles Beam Edge	Beam Diameter
6'	47.2	20.8	3.6'
7'	34.7	15.3	4.2'
8'	26.5	11.7	4.7'
9'	21.0	9.3	5.3'
10'	17.0	7.5	5.9'
11'	14.0	6.2	6.5'
12'	11.8	5.2	7.1'
13'	10.1	4.4	7.7'
14'	8.7	3.8	8.3'
15'	7.6	3.3	8.9'

AVERAGE INITIAL FOOTCANDLES

Reflectances: 80% Ceiling, 50% Walls, 20% Floors

Luminaire Spacing	Room Cavity Ratio		
	RCR1	RCR3	RCR5
4' x 4'	39	36	33
5' x 5'	25	23	21
6' x 6'	17	16	15
7' x 7'	14	13	12
8' x 8'	11	10	9
9' x 9'	8	8	7
10' x 10'	6	6	5
12' x 12'	4	4	4

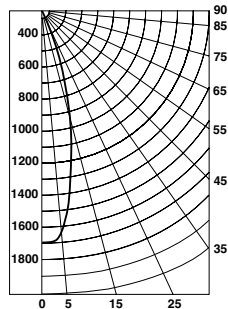

Candlepower Distribution (Candelas)

Angle	Candela	Lumens
0°	1699	
5°	1649	157
15°	957	271
25°	232	107
35°	28	18
45°	0	0
55°	0	0
65°	0	0
75°	0	0
85°	0	0

Luminaire Data

Ang in Deg	Footlamberts	Candela/M <sup>2</sup>
45	0	0
55	0	0
65	0	0
75	0	0
85	0	0

Zonal Lumen Summary

Zone	Lumens	%Lamp	%Fixture
0-30°	536	67.0	96.8
0-40°	554	69.3	100.0
0-60°	554	69.3	100.0
0-90°	554	69.3	100.0
90-180°	0	0.0	0.0
0-180°	554	69.3	100.0

COEFFICIENTS OF UTILIZATION - % (Zonal Cavity Method)

Effective Floor Reflectance 20%

PCC	80		70		50		30		10		0							
	PW	70	50	30	10	70	50	30	10	50	30	10	0					
0	82	82	82	82	81	81	81	81	77	77	77	74	74	74	71	71	71	69
1	80	78	77	76	78	77	75	74	74	73	72	71	71	70	69	68	68	67
2	77	74	72	70	75	73	71	70	71	70	68	69	68	67	67	66	65	64
3	74	71	69	66	73	70	68	66	68	67	65	67	65	64	65	64	63	62
4	72	68	65	63	71	67	65	63	66	64	62	65	63	61	64	62	61	60
5	70	66	63	60	69	65	62	60	64	61	60	63	61	59	62	60	59	58
6	68	63	60	58	67	63	60	58	62	59	57	61	59	57	60	58	57	56
7	66	61	58	56	65	60	58	56	60	57	55	59	57	55	58	56	55	54
8	64	59	56	54	63	59	56	54	58	55	54	57	55	53	57	55	53	52
9	62	57	54	52	61	57	54	52	56	54	52	56	53	52	55	53	52	51
10	60	55	52	50	59	55	52	50	54	52	50	54	52	50	54	51	50	49

PHOTOMETRIC REPORT

Catalog Number: TC43N 3DP CS WHR

Test Number: PT12091503

Total Luminaire Efficiency: 70.0%

Luminaire Spacing Criteria: 0.53

Luminaire: Clear specular Alzak® Downlight Trim. Open Aperture.

Lamps: One 50MR16/1R/FL35/C, rated at 1200 total lumens.

Initial Footcandles

Distance to Illuminated Plane (Feet)	Footcandles Beam Center	Footcandles Beam Edge	Beam Diameter
6'	70.6	31.2	3.5'
7'	51.9	23.0	4.1'
8'	39.7	17.6	4.7'
9'	31.4	13.9	5.3'
10'	25.4	11.2	5.8'
11'	21.0	9.3	6.4'
12'	17.6	7.8	7.0'
13'	15.0	6.7	7.6'
14'	13.0	5.7	8.2'
15'	11.3	5.0	8.8'

AVERAGE INITIAL FOOTCANDLES

Reflectances: 80% Ceiling, 50% Walls, 20% Floors

Luminaire Spacing	Room Cavity Ratio		
	RCR1	RCR3	RCR5
4' x 4'	59	54	50
5' x 5'	38	35	32
6' x 6'	26	24	22
7' x 7'	21	19	18
8' x 8'	17	15	14
9' x 9'	13	12	11
10' x 10'	9	9	8
12' x 12'	7	6	6

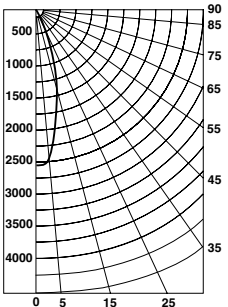

Candlepower Distribution (Candelas)

Angle	Candela	Lumens
0°	2541	
5°	2466	235
15°	1392	395
25°	390	181
35°	44	27
45°	3	2
55°	0	0
65°	0	0
75°	0	0
85°	0	0

Luminaire Data

Ang in Deg	Footlamberts	Candela/M <sup>2</sup>
45	173	594
55	0	0
65	0	0
75	0	0
85	0	0

Zonal Lumen Summary

Zone	Lumens	%Lamp	%Fixture
0-30°	811	67.5	96.5
0-40°	838	69.8	99.8
0-60°	840	70.0	100.0
0-90°	840	70.0	100.0
90-180°	0	0.0	0.0
0-180°	840	70.0	100.0

COEFFICIENTS OF UTILIZATION - % (Zonal Cavity Method)

Effective Floor Reflectance 20%

PCC	80		70		50		30		10		0							
	PW	70	50	30	10	70	50	30	10	50	30	10	0					
0	83	83	83	83	81	81	81	81	78	78	78	74	74	74	71	71	71	70
1	80	79	78	76	79	77	76	75	75	74	73	72	71	71	70	69	69	67
2	78	75	73	71	76	74	72	70	72	70	69	70	68	67	68	67	66	65
3	75	72	69	67	74	71	68	66	69	67	65	67	66	64	66	65	63	63
4	73	69	66	64	71	68	65	63	67	64	63	65	63	62	64	62	61	60
5	70	66	63	61	69	65	63	60	64	62	60	63	61	59	62	60	59	58
6	68	63	60	58	67	63	60	58	62	60	58	61	59	57	60	58	57	56
7	66	61	58	56	65	61	58	56	60	57	56	59	57	55	59	57	55	54
8	64	59	56	54	63	59	56	54	58	56	54	57	55	53	57	55	53	53
9	62	57	54	52	61	57	54	52	56	54	52	56	53	52	55	53	52	51
10	60	55	52	50	60	55	52	50	55	52	50	54	52	50	54	52	50	49

3DBAF Baffle Downlight Trim Aperture : 3 1/4"

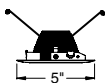

Trim Ring

# 3" MR16 UNIVERSAL RECESSED DOWNLIGHT

MR16 Halogen

## IC43N / TC43N / TC943N with 3DBAF Trim

### PHOTOMETRICS

#### PHOTOMETRIC REPORT

**Catalog Number:** IC43N 3DBAF B WHR  
**Test Number:** PT12090802  
**Total Luminaire Efficiency:** 62.0%  
**Luminaire Spacing Criteria:** 0.53  
**Luminaire:** Black Baffle Trim. Open Aperture.  
**Lamps:** One 37MR16/1R/FL35/C, rated at 800 total lumens.

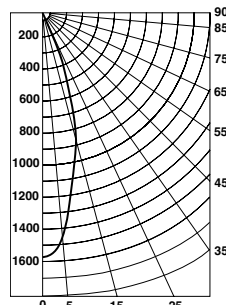

Candlepower Distribution (Candelas)

Angle	Candela	Lumens
0°	1552	
5°	1432	137
15°	852	241
25°	218	101
35°	28	17
45°	0	0
55°	0	0
65°	0	0
75°	0	0
85°	0	0

#### Initial Footcandles

Distance to Illuminated Plane (Feet)	Footcandles Beam Center	Footcandles Beam Edge	Beam Diameter
6'	43.1	19.0	3.5'
7'	31.7	14.0	4.1'
8'	24.3	10.7	4.7'
9'	19.2	8.5	5.3'
10'	15.5	6.9	5.9'
11'	12.8	5.7	6.5'
12'	10.8	4.8	7.0'
13'	9.2	4.1	7.6'
14'	7.9	3.5	8.2'
15'	6.9	3.0	8.8'

#### Luminaire Data

Ang in Deg	Footlamberts	Candela/M <sup>2</sup>
45	0	0
55	0	0
65	0	0
75	0	0
85	0	0

#### Zonal Lumen Summary

Zone	Lumens	%Lamp	%Fixture
0-30°	479	59.9	96.5
0-40°	496	62.0	100.0
0-60°	496	62.0	100.0
0-90°	496	62.0	100.0
90-180°	0	0.0	0.0
0-180°	496	62.0	100.0

#### AVERAGE INITIAL FOOTCANDLES

Reflectances: 80% Ceiling, 50% Walls, 20% Floors

Luminaire Spacing	Room Cavity Ratio		
	RCR1	RCR3	RCR5
4' x 4'	35	32	29
5' x 5'	22	20	19
6' x 6'	16	14	13
7' x 7'	13	12	10
8' x 8'	10	9	8
9' x 9'	8	7	6
10' x 10'	6	5	5
12' x 12'	4	4	3

#### COEFFICIENTS OF UTILIZATION - % (Zonal Cavity Method)

Effective Floor Reflectance 20%

PCC	80		70		50		30		10		0							
	PW	70	50	30	10	70	50	30	10	50	30	10	0					
0	74	74	74	74	72	72	72	72	69	69	69	66	66	66	63	63	63	62
1	71	70	69	68	70	69	68	67	66	65	65	64	63	63	62	61	61	60
2	69	67	65	63	68	65	64	62	64	62	61	62	61	60	60	59	58	58
3	67	64	61	59	65	63	61	59	61	59	58	60	58	57	58	57	56	55
4	64	61	58	56	63	60	58	56	59	57	55	58	56	55	57	55	54	54
5	62	58	56	54	61	58	56	54	57	55	53	56	54	53	55	54	52	52
6	60	56	54	52	60	56	53	52	55	53	51	54	52	51	54	52	51	50
7	58	54	52	50	58	54	51	50	53	51	49	53	51	49	52	50	49	48
8	57	52	50	48	56	52	50	48	52	49	48	51	49	47	50	49	47	47
9	55	51	48	46	55	50	48	46	50	48	46	49	47	46	49	47	46	45
10	53	49	47	45	53	49	46	45	48	46	45	48	46	45	48	46	44	44

#### PHOTOMETRIC REPORT

**Catalog Number:** TC43N 3DBAF W WHR  
**Test Number:** PT12091501  
**Total Luminaire Efficiency:** 66.9%  
**Luminaire Spacing Criteria:** 0.53  
**Luminaire:** White Baffle Trim. Open Aperture.  
**Lamps:** One 50MR16/1R/FL35/C, rated at 1200 total lumens.

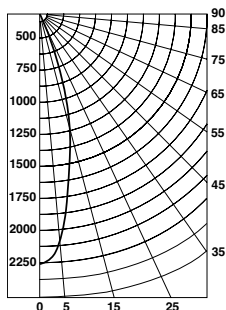

Candlepower Distribution (Candelas)

Angle	Candela	Lumens
0°	2257	
5°	2116	202
15°	1242	352
25°	398	184
35°	55	34
45°	14	11
55°	10	9
65°	6	6
75°	4	4
85°	0	0

#### Initial Footcandles

Distance to Illuminated Plane (Feet)	Footcandles Beam Center	Footcandles Beam Edge	Beam Diameter
6'	62.7	27.6	3.6'
7'	46.1	20.3	4.2'
8'	35.3	15.5	4.8'
9'	27.9	12.3	5.4'
10'	22.6	9.9	6.0'
11'	18.7	8.2	6.5'
12'	15.7	6.9	7.1'
13'	13.4	5.9	7.7'
14'	11.5	5.1	8.3'
15'	10.0	4.4	8.9'

#### Luminaire Data

Ang in Deg	Footlamberts	Candela/M <sup>2</sup>
45	940	3221
55	781	2675
65	697	2386
75	744	2548
85	0	0

#### Zonal Lumen Summary

Zone	Lumens	%Lamp	%Fixture
0-30°	738	61.5	92.0
0-40°	772	64.4	96.3
0-60°	792	66.0	98.7
0-90°	802	66.9	100.0
90-180°	0	0.0	0.0
0-180°	802	66.9	100.0

#### AVERAGE INITIAL FOOTCANDLES

Reflectances: 80% Ceiling, 50% Walls, 20% Floors

Luminaire Spacing	Room Cavity Ratio		
	RCR1	RCR3	RCR5
4' x 4'	56	50	46
5' x 5'	36	32	29
6' x 6'	25	22	20
7' x 7'	20	18	16
8' x 8'	16	14	13
9' x 9'	12	11	10
10' x 10'	9	8	7
12' x 12'	6	6	5

#### COEFFICIENTS OF UTILIZATION - % (Zonal Cavity Method)

Effective Floor Reflectance 20%

PCC	80		70		50		30		10		0							
	PW	70	50	30	10	70	50	30	10	50	30	10	0					
0	80	80	80	80	78	78	78	78	74	74	74	71	71	68	68	68	67	
1	77	75	74	72	75	74	72	71	71	70	69	68	68	67	66	66	65	64
2	74	71	69	67	72	70	68	66	68	66	65	66	64	63	64	63	62	61
3	71	67	65	62	70	66	64	62	65	63	61	63	61	60	62	60	59	58
4	68	64	61	59	67	63	61	59	62	60	58	61	59	57	60	58	57	56
5	66	61	58	56	65	61	58	56	60	57	55	59	57	55	58	56	54	54
6	64	59	56	53	63	58	55	53	57	55	53	57	54	53	56	54	52	51
7	61	57	53	51	61	56	53	51	55	53	51	55	52	51	54	52	50	50
8	59	54	51	49	59	54	51	49	53	51	49	53	50	49	52	50	49	48
9	58	52	49	47	57	52	49	47	52	49	47	51	49	47	51	48	47	46
10	56	51	48	46	55	50	48	46	50	47	45	50	47	45	49	47	45	45



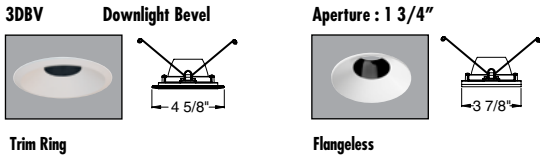

# 3" MR16 UNIVERSAL RECESSED DOWNLIGHT

MR16 Halogen

## IC43N / TC43N / TC943N with 3DBV Trim

### PHOTOMETRICS

#### PHOTOMETRIC REPORT

**Catalog Number:** IC43N 3DBV BS WHSF  
**Test Number:** PT12091004  
**Total Luminaire Efficiency:** 53.8%  
**Luminaire Spacing Criteria:** 0.32  
**Luminaire:** 1 3/4" Regressed Pinhole Trim. Open Aperture.  
**Lamps:** One 37MR16/IR/SP10/C, rated at 800 total lumens.

#### Initial Footcandles

Distance to Illuminated Plane (Feet)	Footcandles Beam Center	Footcandles Beam Edge	Beam Diameter
6'	92.9	45.2	1.6'
7'	68.2	33.2	1.9'
8'	52.2	25.4	2.1'
9'	41.3	20.1	2.4'
10'	33.4	16.3	2.7'
11'	27.6	13.5	2.9'
12'	23.2	11.3	3.2'
13'	19.8	9.6	3.5'
14'	17.1	8.3	3.7'
15'	14.9	7.2	4.0'

#### AVERAGE INITIAL FOOTCANDLES

Reflectances: 80% Ceiling, 50% Walls, 20% Floors

Luminaire Spacing	Room Cavity Ratio		
	RCR1	RCR3	RCR5
4' x 4'	31	29	27
5' x 5'	20	18	17
6' x 6'	14	13	12
7' x 7'	11	10	10
8' x 8'	9	8	8
9' x 9'	7	6	6
10' x 10'	5	5	4
12' x 12'	3	3	3

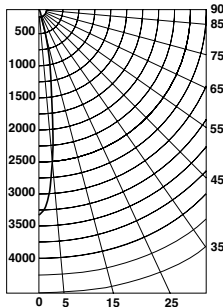

#### Candlepower Distribution

Angle	Candela	Lumens
0°	3343	
5°	2468	236
15°	556	158
25°	71	33
35°	6	4
45°	0	0
55°	0	0
65°	0	0
75°	0	0
85°	0	0

#### Luminance Data

Ang in Deg	Footlamberts	Candela/M <sup>2</sup>
45	0	0
55	0	0
65	0	0
75	0	0
85	0	0

#### Zonal Lumen Summary

Zone	Lumens	%Lamp	%Fixture
0-30°	426	53.3	99.1
0-40°	430	53.8	100.0
0-60°	430	53.8	100.0
0-90°	430	53.8	100.0
90-180°	0	0.0	0.0
0-180°	430	53.8	100.0

#### COEFFICIENTS OF UTILIZATION - % (Zonal Cavity Method)

Effective Floor Reflectance 20%

PCC	80		70		50		30		10		0				
	PW	70	50	30	10	70	50	30	10	50	30	10	0		
0	64	64	64	64	63	63	63	63	60	60	60	57	55	55	54
1	62	61	60	60	61	60	59	59	58	57	57	56	56	55	54
2	61	59	58	56	59	58	57	56	56	55	55	55	54	53	52
3	59	57	55	54	58	56	55	54	55	54	53	54	53	52	51
4	58	55	54	52	57	55	53	52	54	52	51	53	52	51	50
5	56	54	52	51	56	53	52	50	53	51	50	52	51	50	49
6	55	53	51	49	55	52	50	49	51	50	49	51	50	49	48
7	54	51	50	48	54	51	49	48	50	49	48	50	49	48	47
8	53	50	48	47	53	50	48	47	50	48	47	49	48	47	46
9	52	49	48	46	52	49	47	46	49	47	46	48	47	46	45
10	51	48	47	46	51	48	47	45	48	46	45	48	46	45	45

#### PHOTOMETRIC REPORT

**Catalog Number:** TC43N 3DBV BS WHSF  
**Test Number:** PT12091606  
**Total Luminaire Efficiency:** 47.9%  
**Luminaire Spacing Criteria:** 0.29  
**Luminaire:** 1 3/4" Regressed Pinhole Trim. Open Aperture.  
**Lamps:** One 50MR16/IR/SP10/C, rated at 1200 total lumens.

#### Initial Footcandles

Distance to Illuminated Plane (Feet)	Footcandles Beam Center	Footcandles Beam Edge	Beam Diameter
6'	144.5	70.7	1.4'
7'	106.2	51.9	1.7'
8'	81.3	39.8	1.9'
9'	64.2	31.4	2.2'
10'	52.0	25.5	2.4'
11'	43.0	21.0	2.6'
12'	36.1	17.7	2.9'
13'	30.8	15.1	3.1'
14'	26.5	13.0	3.4'
15'	23.1	11.3	3.6'

#### AVERAGE INITIAL FOOTCANDLES

Reflectances: 80% Ceiling, 50% Walls, 20% Floors

Luminaire Spacing	Room Cavity Ratio		
	RCR1	RCR3	RCR5
4' x 4'	41	38	36
5' x 5'	26	24	23
6' x 6'	18	17	16
7' x 7'	15	14	13
8' x 8'	12	11	10
9' x 9'	9	8	8
10' x 10'	7	6	6
12' x 12'	5	4	4

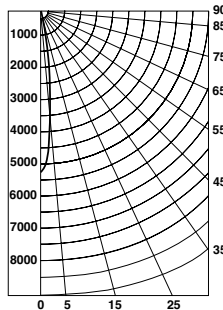

#### Candlepower Distribution

Angle	Candela	Lumens
0°	5202	
5°	3594	343
15°	660	187
25°	80	37
35°	11	7
45°	1	1
55°	0	0
65°	0	0
75°	0	0
85°	0	0

#### Luminance Data

Ang in Deg	Footlamberts	Candela/M <sup>2</sup>
45	66	228
55	0	0
65	0	0
75	0	0
85	0	0

#### Zonal Lumen Summary

Zone	Lumens	%Lamp	%Fixture
0-30°	567	47.2	98.7
0-40°	574	47.8	99.9
0-60°	575	47.9	100.0
0-90°	575	47.9	100.0
90-180°	0	0.0	0.0
0-180°	575	47.9	100.0

#### COEFFICIENTS OF UTILIZATION - % (Zonal Cavity Method)

Effective Floor Reflectance 20%

PCC	80		70		50		30		10		0				
	PW	70	50	30	10	70	50	30	10	50	30	10	0		
0	57	57	57	57	56	56	56	56	53	53	53	51	51	51	49
1	55	55	54	53	54	54	53	52	52	51	51	50	50	49	48
2	54	53	51	50	53	52	51	50	50	49	49	49	48	48	47
3	53	51	49	48	52	50	49	48	49	48	47	48	47	47	46
4	52	49	48	47	51	49	48	47	48	47	46	47	46	46	45
5	51	48	47	46	50	48	46	45	47	46	45	46	45	45	44
6	50	47	46	44	49	47	45	44	46	45	44	46	45	44	44
7	49	46	45	44	48	46	44	43	45	44	43	45	44	43	42
8	48	45	44	43	47	45	44	43	45	43	42	44	43	42	42
9	47	44	43	42	47	44	43	42	44	43	42	44	43	42	41
10	46	44	42	41	46	44	42	41	43	42	41	43	42	41	41

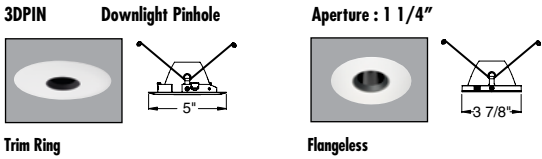

# 3" MR16 UNIVERSAL RECESSED DOWNLIGHT

MR16 Halogen

## IC43N / TC43N / TC943N with 3DPIN Trim

### PHOTOMETRICS

#### PHOTOMETRIC REPORT

**Catalog Number:** IC43N 3DPIN BS WHSF  
**Test Number:** PT12091001  
**Total Luminaire Efficiency:** 38.2%  
**Luminaire Spacing Criteria:** 0.32  
**Luminaire:** 1 1/4" Pinhole Trim, Open Aperture.  
**Lamps:** One 37MR16/1R/SP10/C, rated at 800 total lumens.

#### Initial Footcandles

Distance to Illuminated Plane (Feet)	Footcandles Beam Center	Footcandles Beam Edge	Beam Diameter
6'	71.7	34.9	1.6'
7'	52.7	25.7	1.9'
8'	40.3	19.6	2.1'
9'	31.9	15.5	2.4'
10'	25.8	12.6	2.7'
11'	21.3	10.4	2.9'
12'	17.9	8.7	3.2'
13'	15.3	7.4	3.5'
14'	13.2	6.4	3.7'
15'	11.5	5.6	4.0'

#### AVERAGE INITIAL FOOTCANDLES

Reflectances: 80% Ceiling, 50% Walls, 20% Floors

Luminaire Spacing	Room Cavity Ratio		
	RCR1	RCR3	RCR5
4' x 4'	22	21	20
5' x 5'	14	13	12
6' x 6'	10	9	9
7' x 7'	8	7	7
8' x 8'	6	6	6
9' x 9'	5	4	4
10' x 10'	4	3	3
12' x 12'	2	2	2

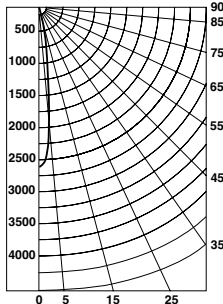

#### Candlepower Distribution

Angle	Candela	Lumens
0°	2581	
5°	2011	192
15°	376	107
25°	15	7
35°	0	0
45°	0	0
55°	0	0
65°	0	0
75°	0	0
85°	0	0

#### Luminance Data

Ang in Deg	Footlamberts	Candela/M <sup>2</sup>
45	0	0
55	0	0
65	0	0
75	0	0
85	0	0

#### Zonal Lumen Summary

Zone	Lumens	%Lamp	%Fixture
0-30°	305	38.2	100.0
0-40°	305	38.2	100.0
0-60°	305	38.2	100.0
0-90°	305	38.2	100.0
90-180°	0	0.0	0.0
0-180°	305	38.2	100.0

#### COEFFICIENTS OF UTILIZATION - % (Zonal Cavity Method)

Effective Floor Reflectance 20%

PCC	80			70			50			30			10			0			
	PW	70	50	30	10	70	50	30	10	50	30	10	50	30	10	0	30	10	0
0	45	45	45	45	44	44	44	44	42	42	42	41	41	41	39	39	39	38	38
1	44	44	43	42	43	43	42	42	41	41	41	40	40	39	39	38	38	38	38
2	43	42	41	40	42	41	41	40	40	40	39	39	39	38	38	38	38	38	37
3	42	41	40	39	42	40	39	39	39	39	38	39	38	37	38	37	37	37	36
4	41	40	39	38	41	39	38	38	39	38	37	38	37	37	37	37	37	36	36
5	41	39	38	37	40	39	38	37	38	37	36	38	37	36	37	36	36	36	36
6	40	38	37	36	40	38	37	36	37	36	36	37	36	36	37	36	36	35	35
7	39	37	36	35	39	37	36	35	37	36	35	37	36	35	36	35	35	35	35
8	39	37	36	35	38	37	36	35	36	35	35	36	35	35	36	35	34	34	34
9	38	36	35	34	38	36	35	34	36	35	34	36	35	34	35	35	34	34	34
10	38	36	35	34	37	36	35	34	35	34	34	35	34	34	35	34	34	33	33

#### PHOTOMETRIC REPORT

**Catalog Number:** TC43N 3DPIN BS WHSF  
**Test Number:** PT12091605  
**Total Luminaire Efficiency:** 30.8%  
**Luminaire Spacing Criteria:** 0.28  
**Luminaire:** 1 1/4" Pinhole Trim, Open Aperture.  
**Lamps:** One 50MR16/1R/SP10/C, rated at 1200 total lumens.

#### Initial Footcandles

Distance to Illuminated Plane (Feet)	Footcandles Beam Center	Footcandles Beam Edge	Beam Diameter
6'	106.4	52.2	1.4'
7'	78.2	38.3	1.6'
8'	59.9	29.3	1.8'
9'	47.3	23.2	2.1'
10'	38.3	18.8	2.3'
11'	31.7	15.5	2.5'
12'	26.6	13.0	2.8'
13'	22.7	11.1	3.0'
14'	19.5	9.6	3.2'
15'	17.0	8.3	3.4'

#### AVERAGE INITIAL FOOTCANDLES

Reflectances: 80% Ceiling, 50% Walls, 20% Floors

Luminaire Spacing	Room Cavity Ratio		
	RCR1	RCR3	RCR5
4' x 4'	26	25	24
5' x 5'	17	16	15
6' x 6'	12	11	11
7' x 7'	9	9	9
8' x 8'	7	7	7
9' x 9'	6	5	5
10' x 10'	4	4	4
12' x 12'	3	3	3

#### COEFFICIENTS OF UTILIZATION - % (Zonal Cavity Method)

Effective Floor Reflectance 20%

PCC	80			70			50			30			10			0			
	PW	70	50	30	10	70	50	30	10	50	30	10	50	30	10	0	30	10	0
0	37	37	37	37	36	36	36	36	34	34	34	33	33	33	31	31	31	31	31
1	36	35	35	34	35	35	34	34	33	33	33	32	32	32	31	31	31	31	30
2	35	34	33	33	34	34	33	32	33	32	32	32	31	31	31	31	30	30	30
3	34	33	32	32	34	33	32	31	32	31	31	31	31	30	31	30	30	30	29
4	34	32	31	31	33	32	31	31	31	31	30	31	30	30	30	30	30	29	29
5	33	32	31	30	33	31	31	30	31	30	30	30	30	29	30	30	29	29	29
6	32	31	30	29	32	31	30	29	30	30	29	30	29	29	30	29	29	29	29
7	32	31	30	29	32	30	30	29	30	29	29	30	29	29	30	29	29	29	28
8	31	30	29	29	31	30	29	29	30	29	28	29	29	28	29	29	28	28	28
9	31	30	29	28	31	30	29	28	29	29	28	29	28	28	29	28	28	28	28
10	31	29	28	28	30	29	28	28	29	28	28	29	28	28	29	28	28	28	27

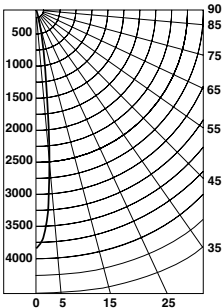

#### Candlepower Distribution

Angle	Candela	Lumens
0°	3831	
5°	2647	253
15°	381	108
25°	18	8
35°	0	0
45°	0	0
55°	0	0
65°	0	0
75°	0	0
85°	0	0

#### Luminance Data

Ang in Deg	Footlamberts	Candela/M <sup>2</sup>
45	0	0
55	0	0
65	0	0
75	0	0
85	0	0

#### Zonal Lumen Summary

Zone	Lumens	%Lamp	%Fixture
0-30°	369	30.8	100.0
0-40°	369	30.8	100.0
0-60°	369	30.8	100.0
0-90°	369	30.8	100.0
90-180°	0	0.0	0.0
0-180°	369	30.8	100.0



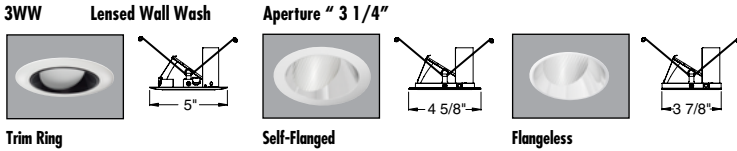

# 3" MR16 UNIVERSAL RECESSED WALL WASH

MR16 Halogen

## IC43N / TC43N / TC943N with 3WW Trim

### PHOTOMETRICS

#### PHOTOMETRIC REPORT

Catalog Number: IC43N 3WW CS WHR

Test Number: PT03101003

Total Luminaire Efficiency: 63.8%

Luminaire Spacing Criteria @ 90°: 0.70

Luminaire: Clear Alzak® finish, lensed angle cut wall wash trim.

Lamps: One 37MR16/IR/FL35/C, rated at 800 total lumens.

#### Luminaire Data

Ang in Deg	Footlamberts	Candela/M <sup>2</sup>
45	1086	3723
55	0	0
65	0	0
75	0	0
85	0	0

#### Zonal Lumen Summary

Zone	Lumens	%Lamp	%Fixture
0-30°	334	41.7	65.4
0-40°	426	53.3	83.5
0-60°	502	62.8	98.5
0-90°	510	63.8	100.0
90-180°	0	0.0	0.0
0-180°	510	63.8	100.0

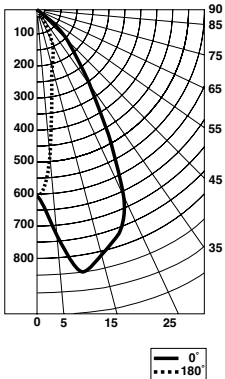

#### Candlepower Distribution (Candelas)

Degrees Vertical	0° Wall Wash	180° Downlight
0°	603	603
5°	742	481
15°	816	207
25°	664	129
35°	309	41
45°	173	16
55°	63	0
65°	21	0
75°	8	0
85°	0	0

#### Footcandles on Wall from Multiple Fixtures

Fixture Distance to Wall Fixture Centers (spacing)	18"						24"					
	18"		24"		18"		24"					
1'	18	12	18	16	7	16	7	6	7	6	4	6
2'	38	39	38	31	24	31	25	24	25	20	17	20
3'	37	35	37	30	25	30	28	30	28	22	23	22
4'	30	27	30	22	21	22	28	26	28	21	20	21
5'	21	20	21	16	15	16	24	22	24	18	17	18
6'	15	15	15	11	11	11	19	19	19	14	14	14
7'	11	11	11	8	8	8	14	15	14	11	11	11
8'	9	9	9	7	6	7	11	11	11	9	8	9
9'	7	7	7	5	5	5	9	9	9	7	7	7

\*Multipliers: Black - 0.7, Diffuse - 0.95

\*Note: Multipliers are provided for estimating purposes only. Use IES photometric files for precise photometric information.

#### PHOTOMETRIC REPORT

Catalog Number: TC43N 3WW CS WHR

Test Number: PT03101102

Total Luminaire Efficiency: 61.9%

Luminaire Spacing Criteria @ 90°: 0.65

Luminaire: Clear Alzak® finish, lensed angle cut wall wash trim.

Lamps: One 50MR16/IR/FL35, rated at 1200 total lumens.

#### Luminaire Data @ 180° Downlight

Ang in Deg	Footlamberts	Candela/M <sup>2</sup>
45	2968	10169
55	0	0
65	0	0
75	0	0
85	0	0

#### Zonal Lumen Summary

Zone	Lumens	%Lamp	%Fixture
0-30°	512	42.6	68.9
0-40°	626	52.2	84.3
0-60°	727	60.6	97.9
0-90°	742	61.9	100.0
90-180°	0	0.0	0.0
0-180°	742	61.9	100.0

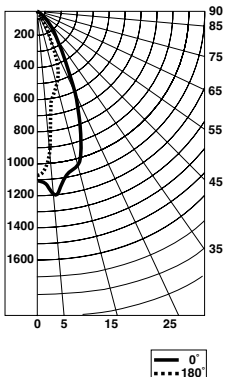

#### Candlepower Distribution (Candelas)

Degrees Vertical	0° Wall Wash	180° Downlight
0°	1075	1075
5°	1177	924
15°	998	506
25°	606	272
35°	270	112
45°	167	45
55°	77	0
65°	43	0
75°	14	0
85°	0	0

#### Footcandles on Wall from Multiple Fixtures

Fixture Distance to Wall Fixture Centers (spacing)	18"						24"					
	18"		24"		18"		24"					
1'	26	21	26	22	13	22	14	11	14	11	8	11
2'	38	34	38	30	24	30	27	26	27	21	19	21
3'	35	34	35	29	24	29	26	26	26	21	19	21
4'	34	31	34	25	24	25	27	26	27	20	20	20
5'	26	24	26	19	19	19	26	24	26	20	18	20
6'	19	19	19	14	14	14	22	22	22	17	16	17
7'	14	15	14	11	11	11	18	18	18	14	13	14
8'	11	12	11	9	9	9	14	15	14	11	11	11
9'	10	10	10	7	7	7	12	12	12	9	9	9

\*Multipliers: Black - 0.7, Diffuse - 0.95

\*Note: Multipliers are provided for estimating purposes only. Use IES photometric files for precise photometric information.